

## Universele moerkap voor esthetische afwerking

Polyethyleen LD-PE | zwart - wit - grijs (andere kleuren op aanvraag)

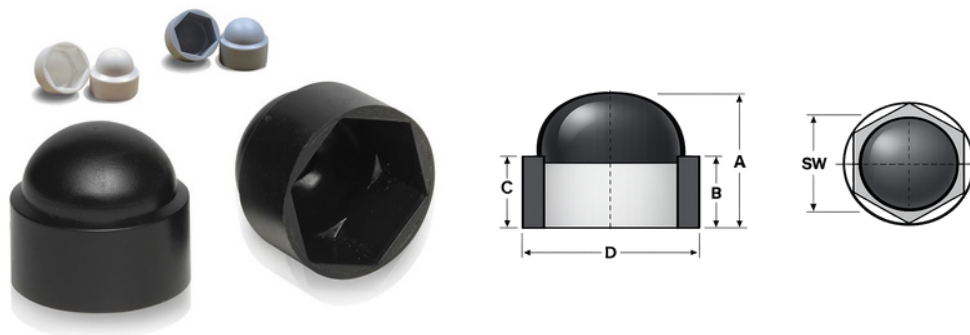

Artikelnummer	Sleutelwijdte mm (SW)	A	C	B	D
BM4	7,0	9,4	6,0	6,3	10,7
BM5	8,0	9,5	6,0	5,9	10,6
BM6	10,0	12,5	6,7	5,7	12,8
BM8	13,0	16,5	8,8	8,4	16,6
BM10	17,0	18,8	9,8	9,4	20,9
BM12	19,0	21,5	12,2	11,1	23,5
BM14	22,0	23,7	13,0	12,1	27,0
BM16	24,0	26,9	16,1	13,7	29,4
BM18	27,0	30,3	17,9	17,4	33,3
BM20	30,0	33,5	19,4	18,0	36,5
BM22	32,0	36,0	21,2	20,0	38,9
BM24	36,0	39,3	22,8	20,2	43,9
BM27	41,0	46,9	25,9	24,1	50,0
BM30	46,0	51,3	28,0	24,8	56,0
BM33	50,0	56,2	30,3	28,3	59,5

## Universele moerkap voor esthetische afwerking

Polyethyleen LD-PE | zwart - wit - grijs (andere kleuren op aanvraag)

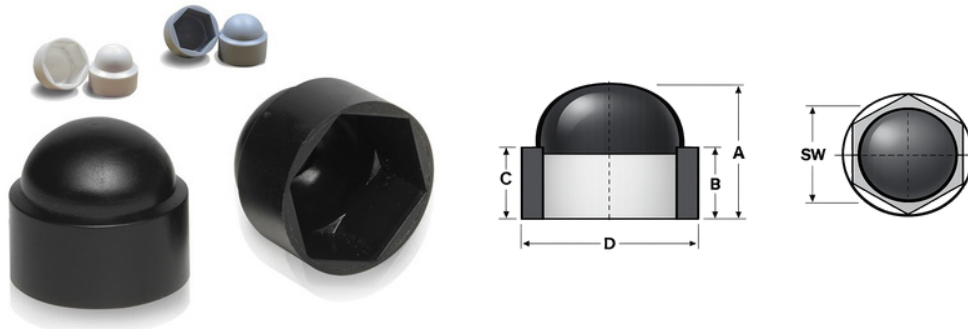

Artikelnummer	Sleutelwijdte mm (SW)	A	C	B	D
BM36	55,0	58,0	32,5	29,2	66,0
BM39	60,0	61,0	37,6	34,6	72,0
BM42	65,0	63,1	39,1	36,6	76,6
BM45	70,0	88,4	39,0	34,5	84,0
BM48	75,0	79,0	42,0	36,0	91,6
BM52	80,0	86,2	46,0	38,0	98,0
BM56	85,0	91,6	51,0	42,0	104,2
BM64	95,0	105,5	58,0	48,7	116,7



## Toepassingen:

Afwerking bescherming en conservering van boutkop en moer

## Speciale moerkappen - anti corrosie - vandalisme - afwerking

Polyethyleen LD-PE | zwart standaard - alle RAL-kleuren mogelijk op aanvraag



Artikelnummer	Sleutelwijdte SW (mm)	Metrisch	UNC	Max.hoogte a (mm)	Ø b (mm)
SW5,5-7	5,5	M3		7	8,8
SW7-4	7	M4		4	11
SW8-5	8	M5		5	12.0
SW8-10	8	M5		10	12.0
SW10,5-6FK	10,5 (DIN84)	M5		6	15
SW10,6-6FK	10,6 (DIN85)	M6		6	15
SW10-6	10	M6		6	15.0
SW10-11	10	M6		11	15.0
SW10-16	10	M6		16	15.0
SW10-34	10	M6		34	15.0
SW12-7	12	M7		7	17.7
SW13-8	13	M8	1/4"	8	18.5
SW13-13	13	M8	1/4"	13	18.5
SW13-18	13	M8	1/4"	18	18.5
SW13-27		M8	1/4"	27	18.5
SW14-13		M8	5/16	13	20.20

## Speciale moerkappen - anti corrosie - vandalisme - afwerking

Polyethyleen LD-PE | zwart standaard - alle RAL-kleuren mogelijk op aanvraag



Artikelnummer	Sleutelwijdte SW (mm)	Metrisch	UNC	Max.hoogte a (mm)	Ø b (mm)
SW14-27T*	14	M8	5/16	27 telescopisch	20.20
SW16-10	16	M10		10	23.5
SW16-29	16	M10		29	23.5
SW17-10	17	M10	3/8"	10	23.5
SW17-15	17	M10	3/8"	15	23.5
SW17-20	17	M10	3/8"	20	23.5
SW17-24	17	M10	3/8"	24	23.5
SW17-29	17	M10	3/8"	29	23.5
SW17-45	17	M10	3/8"	45	23.5
SW18-22	18	M12	7/16"	22	26.1
SW19-12	19	M12	7/16"	12	26.1
SW19-17	19	M12	7/16"	17	26.1
SW19-22	19	M12	7/16"	22	26.1
SW19-27	19	M12	7/16"	27	26.1
SW19-37	19	M12	7/16"	37	26.1
SW19-50	19	M12	7/16"	50	26.1

## Speciale moerkappen - anti corrosie - vandalisme - afwerking

Polyethyleen LD-PE | zwart standaard - alle RAL-kleuren mogelijk op aanvraag



Artikelnummer	Sleutelwijdte SW (mm)	Metrisch	UNC	Max.hoogte a (mm)	Ø b (mm)
SW19-74T	19	M12	7/16"	74	26.1
SW22-11	22	M14	1/2"	11	29.0
SW22-24	22	M14	1/2"	24	30.3
SW22-35	22	M14	1/2"	35	30.3
SW22-40T*	22	M14	1/2"	40	30.3
SW22-44T*	22	M14	1/2"	44	30.3
SW22-51T	22	M14	1/2"	51	30.3
SW22-60T	22	M14	1/2"	60	30.3
SW22-64	22	M14	1/2"	64	30.3
SW22-77T	22	M14	1/2"	77	30.3
SW22-87T	22	M14	1/2"	87	30.3
SW24-11	24	M16	9/16"	11	32.3
SW24-21	24	M16	9/16"	21	32.3
SW24-26	24	M16	9/16"	26	32.3
SW24-31	24	M16	9/16"	31	32.3
SW24-41	24	M16	9/16"	41	32.3

## Speciale moerkappen - anti corrosie - vandalisme - afwerking

Polyethyleen LD-PE | zwart standaard - alle RAL-kleuren mogelijk op aanvraag



Artikelnummer	Sleutelwijdte SW (mm)	Metrisch	UNC	Max.hoogte a (mm)	Ø b (mm)
SW24-41T*	24	M16	9/16"	41	32.3
SW24-51	24	M16	9/16"	51	32.3
SW24-62T*	24	M16	9/16"	62	32.3
SW24-66T	24	M16	9/16"	66	32.3
SW24-70T	24	M16	9/16"	70	32.3
SW24-87T	24	M16	9/16"	87	32.3
SW27-23	27	M18	5/8"	23	36.9
SW27-30	27	M18	5/8"	30	36.9
SW27-38	27	M18	5/8"	38	36.9
SW27-48T*	27	M18	5/8"	48	36.9
SW27-53T*	27	M18	5/8"	53	36.9
SW27-63T*	27	M18	5/8"	63	36.9
SW27-76T*	27	M18	5/8"	76	36.9
SW27-84T	27	M18	5/8"	84	36.9
SW30-14	30	M20		14	40.4
SW30-24	30	M20		24	40.4

## Speciale moerkappen - anti corrosie - vandalisme - afwerking

Polyethyleen LD-PE | zwart standaard - alle RAL-kleuren mogelijk op aanvraag



Artikelnummer	Sleutelwijdte SW (mm)	Metrisch	UNC	Max.hoogte a (mm)	Ø b (mm)
SW30-28	30	M20		28	40.4
SW30-34	30	M20		34	40.4
SW30-39	30	M20		39	40.4
SW30-47	30	M20		47	40.4
SW30-67T*	30	M20		67	40.4
SW30-79	30	M20		79	40.4
SW30-90T	30	M20		90	40.4
SW30-92T*	30	M20		92	40.4
SW30-109T	30	M20		109	40.4
SW30-120	30	M20		120	40.4
SW30-175T	30	M20		175	40.4
SW32-27	32	M22	3/4"	27	42.1
SW32-37	32	M22	3/4"	37	42.1
SW32-72	32	M22	3/4"	72	42.1
SW32-95T*	32	M22	3/4"	95	42.1
SW32-103T	32	M22	3/4"	103	42.1

## Speciale moerkappen - anti corrosie - vandalisme - afwerking

Polyethyleen LD-PE | zwart standaard - alle RAL-kleuren mogelijk op aanvraag



Artikelnummer	Sleutelwijdte SW (mm)	Metrisch	UNC	Max.hoogte a (mm)	Ø b (mm)
SW32-128T	32	M22	3/4"	128	42.1
SW36-28	36	M24	7/8"	28	47.2
SW36-33	36	M24	7/8"	33	47.2
SW36-38	36	M24	7/8"	38	47.2
SW36-43	36	M24	7/8"	43	47.2
SW36-52	36	M24	7/8"	52	47.2
SW36-69T	36	M24	7/8"	69	47.2
SW36-73	36	M24	7/8"	73	47.2
SW36-88T	36	M24	7/8"	88	47.2
SW36-98T	36	M24	7/8"	98	47.2
SW36-117T	36	M24	7/8"	117	47.2
SW36-145T	36	M24	7/8"	145	47.2
SW41-31	41	M27	1"	31	53.4
SW41-41	41	M27	1"	41	53.4
SW41-46	41	M27	1"	46	53.4
SW41-51	41	M27	1"	51	53.4

## Speciale moerkappen - anti corrosie - vandalisme - afwerking

Polyethyleen LD-PE | zwart standaard - alle RAL-kleuren mogelijk op aanvraag



Artikelnummer	Sleutelwijdte SW (mm)	Metrisch	UNC	Max.hoogte a (mm)	Ø b (mm)
SW41-66T*	41	M27	1"	66	53.4
SW41-69T*	41	M27	1"	69	53.4
SW41-76	41	M27	1"	76	53.4
SW41-98T	41	M27	1"	98	53.4
SW41-101T	41	M27	1"	101	53.4
SW41-115T	41	M27	1"	115	53.4
SW41-150T	41	M27	1"	150	53.4
SW41-191T	41	M27	1"	191	53.4
SW46-34	46	M30	1-1/8"	34	59.5
SW46-44	46	M30	1-1/8"	44	59.5
SW46-49	46	M30	1-1/8"	49	59.5
SW46-79	46	M30	1-1/8"	79	59.5
SW46-83T*	46	M30	1-1/8"	83	59.5
SW46-92T*	46	M30	1-1/8"	92	59.5
SW46-112T	46	M30	1-1/8"	112	59.5
SW46-121T	46	M30	1-1/8"	121	59.5

## Speciale moerkappen - anti corrosie - vandalisme - afwerking

Polyethyleen LD-PE | zwart standaard - alle RAL-kleuren mogelijk op aanvraag



Artikelnummer	Sleutelwijdte SW (mm)	Metrisch	UNC	Max.hoogte a (mm)	Ø b (mm)
SW46-144	46	M30	1-1/8"	144	59.5
SW46-150T	46	M30	1-1/8"	150	59.5
SW46-185T	46	M30	1-1/8"	185	59.5
SW46-190T	46	M30	1-1/8"	190	59.5
SW46-221T	46	M30	1-1/8"	221	59.5
SW46-256T	46	M30	1-1/8"	256	59.5
SW50-51	50	M33	1-1/4"	51	64.2
SW50-81	50	M33	1-1/4"	81	64.2
SW50-83T*	50	M33	1-1/4"	83	64.2
SW50-111T	50	M33	1-1/4"	111	64.2
SW50-115T*	50	M33	1-1/4"	115	64.2
SW50-144T	50	M33	1-1/4"	144	64.2
SW50-190T	50	M33	1-1/4"	190	64.2
SW55-55	55	M36	1-3/8"	55	70.2
SW55-85	55	M36	1-3/8"	85	70.2
SW55-92T*	55	M36	1-3/8"	92	70.2

## Speciale moerkappen - anti corrosie - vandalisme - afwerking

Polyethyleen LD-PE | zwart standaard - alle RAL-kleuren mogelijk op aanvraag



Artikelnummer	Sleutelwijdte SW (mm)	Metrisch	UNC	Max.hoogte a (mm)	Ø b (mm)
SW55-101T*	55	M36	1-3/8"	101	70.2
SW55-120T	55	M36	1-3/8"	120	70.2
SW55-121T*	55	M36	1-3/8"	121	70.2
SW55-149T	55	M36	1-3/8"	149	70.2
SW55-155	55	M36	1-3/8"	155	70.2
SW55-192T	55	M36	1-3/8"	192	70.2
SW55-201T	55	M36	1-3/8"	201	70.2
SW55-225T	55	M36	1-3/8"	225	70.2
SW55-264T	55	M36	1-3/8"	264	70.2
SW60-57	60	M39	1-1/2"	57	78.6
SW60-87	60	M39	1-1/2"	87	78.6
SW60-97T*	60	M36	1-1/2"	97	78.6
SW60-107	60	M39	1-1/2"	107	78.6
SW60-125T	60	M39	1-1/2"	125	78.6
SW60-126T*	60	M39	1-1/2"	126	78.6
SW60-139T	60	M39	1-1/2"	139	78.6

## Speciale moerkappen - anti corrosie - vandalisme - afwerking

Polyethyleen LD-PE | zwart standaard - alle RAL-kleuren mogelijk op aanvraag



Artikelnummer	Sleutelwijdte SW (mm)	Metrisch	UNC	Max.hoogte a (mm)	Ø b (mm)
SW60-154T	60	M39	1-1/2"	154	78.6
SW60-174T	60	M39	1-1/2"	174	78.6
SW60-220T	60	M39	1-1/2"	220	78.6
SW60-240T	60	M39	1-1/2"	240	78.6
SW65-61	65	M42	1-5/8"	61	84.8
SW65-91	65	M42	1-5/8"	91	84.8
SW65-100T*	65	M42	1-5/8"	100	84.8
SW65-123	65	M42	1-5/8"	123	84.8
SW65-128T*	65	M42	1-5/8"	128	84.8
SW65-129T	65	M42	1-5/8"	129	84.8
SW65-145	65	M42	1-5/8"	145	94.0
SW65-158T	65	M42	1-5/8"	158	84.8
SW65-191T	65	M42	1-5/8"	191	84.8
SW65-257T	65	M42	1-5/8"	257	84.8
SW70-63	70	M45	1-3/4"	63	90.9
SW70-93	70	M45	1-3/4"	93	90.9

## Speciale moerkappen - anti corrosie - vandalisme - afwerking

Polyethyleen LD-PE | zwart standaard - alle RAL-kleuren mogelijk op aanvraag

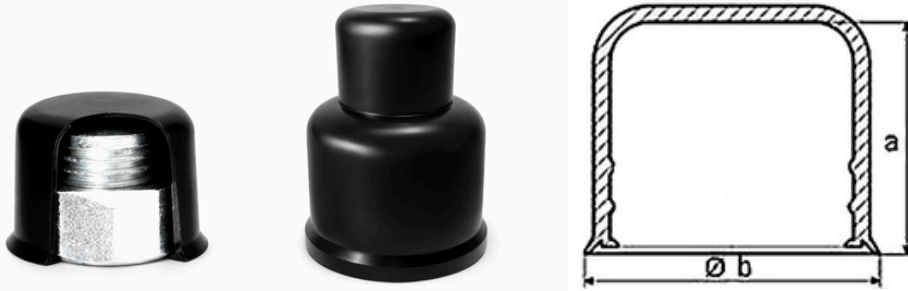

Artikelnummer	Sleutelwijdte SW (mm)	Metrisch	UNC	Max.hoogte a (mm)	Ø b (mm)
SW70-105T*	70	M45	1-3/4"	105	90.9
SW70-133	70	M45	1-3/4"	133	90.9
SW70-133T*	70	M45	1-3/4"	133	90.9
SW70-134T	70	M45	1-3/4"	134	90.9
SW70-163T	70	M45	1-3/4"	163	90.9
SW75-66	75	M48	1-7/8"	66	97.0
SW75-96	75	M48	1-7/8"	96	97.0
SW75-108T*	75	M48	1-7/8"	108	97.0
SW75-137T*	75	M48	1-7/8"	137	97.0
SW75-138T	75	M48	1-7/8"	138	97.0
SW75-166T	75	M48	1-7/8"	166	97.0
SW75-200T*	75	M48	1-7/8"	200	97.0
SW75-230T	75	M48	1-7/8"	230	97.0
SW80-70	80	M52	2"	70	105.0
SW80-114T*	80	M52	2"	114	105.0
SW80-130	80	M52	2"	130	105.0

## Speciale moerkappen - anti corrosie - vandalisme - afwerking

Polyethyleen LD-PE | zwart standaard - alle RAL-kleuren mogelijk op aanvraag

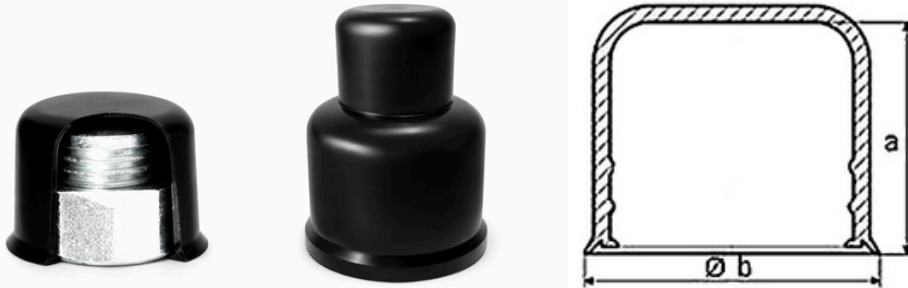

Artikelnummer	Sleutelwijdte SW (mm)	Metrisch	UNC	Max.hoogte a (mm)	Ø b (mm)
SW80-142T*	80	M52	2"	142	105.0
SW80-171T	80	M52	2"	171	105.0
SW80-201T	80	M52	2"	201	105.0
SW80-275T	80	M52	2"	275	105.0
SW85-74	85	M56		74	109.0
SW85-122T*	85	M56		122	109.0
SW85-134	85	M56		134	109.0
SW85-150T	85	M56		150	109.0
SW85-179T	85	M56		179	109.0
SW85-209T	85	M56		209	109.0
SW90-78	90	M60	2-1/4"	78	120.0
SW90-128T*	90	M60	2-1/4"	128	120.0
SW90-140	90	M60	2-1/4"	140	120.0
SW90-156T*	90	M60	2-1/4"	156	120.0
SW90-182T	90	M60	2-1/4"	182	120.0
SW90-212T	90	M60	2-1/4"	212	120.0

## Speciale moerkappen - anti corrosie - vandalisme - afwerking

Polyethyleen LD-PE | zwart standaard - alle RAL-kleuren mogelijk op aanvraag



Artikelnummer	Sleutelwijdte SW (mm)	Metrisch	UNC	Max.hoogte a (mm)	Ø b (mm)
SW95-86	95	M64		86	122.0
SW95-140T*	95	M64		140	122.0
SW95-143	95	M64		143	122.0
SW95-169T*	95	M64		169	122.0
SW95-189T	95	M64		189	122.0
SW95-219T	95	M64		219	122.0
SW100-90	100	M68	2-1/2"	90	125.0
SW100-144T*	100	M68	2-1/2"	144	125.0
SW100-173T*	100	M68	2-1/2"	173	125.0
SW100-213T*	100	M68	2-1/2"	223	125.0
SW105-90	105	M72		90	135.0
SW105-147T*	105	M72		147	135.0
SW105-150	105	M72		150	135.0
SW105-176T*	105	M72		176	135.0
SW105-204T	105	M72		204	135.0
SW105-233T	105	M72		233	135.0

## Speciale moerkappen - anti corrosie - vandalisme - afwerking

Polyethyleen LD-PE | zwart standaard - alle RAL-kleuren mogelijk op aanvraag

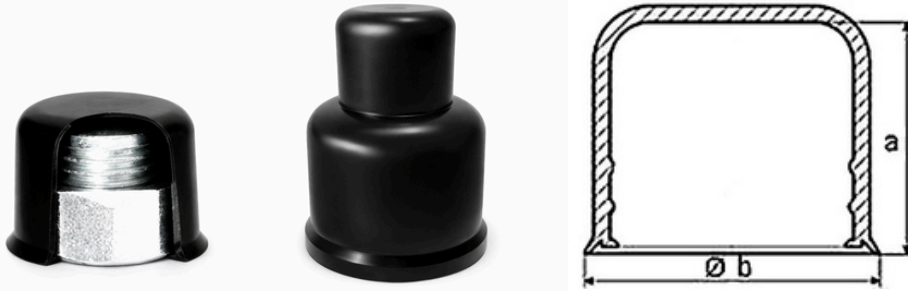

Artikelnummer	Sleutelwijdte SW (mm)	Metrisch	UNC	Max.hoogte a (mm)	Ø b (mm)
SW105-270T	105	M72		270	135.0
SW107-95	107	M76	2-3/4"	95	137.0
SW107-145T*	107	M76	2-3/4"	145	137.0
SW107-205T*	107	M76	2-3/4"	205	137.0
SW115-60	115	M80		60	152.0
SW115-214T	115	M80		214	152.0
SW115-274T	115	M80		274	152.0
SW117-100	117	M85	3"	100	155.0
SW117-158T*	117	M85	3"	158	155.0
SW117-220T*	117	M85	3"	220	155.0
SW130-100	130	M90	3-1/4"	100	173.0
SW130-166T*	130	M90	3-1/4"	166	173.0
SW130-223T*	130	M90	3-1/4"	223	173.0
SW135-145	135		3-1/2"	145	178.0
SW135-205T*	135		3-1/2"	205	178.0
SW135-265T*	135		3-1/2"	265	178.0

**Speciale moerkappen - anti corrosie - vandalisme - afwerking**

Polyethyleen LD-PE | zwart standaard - alle RAL-kleuren mogelijk op aanvraag



## Toepassingen:

Afwerking bescherming en conservering van boutkop en moer

## Moerkappen + onderlegging bescherming - anti corrosie

Polyethyleen LD-PE | zwart standaard - alle RAL-kleuren mogelijk op aanvraag

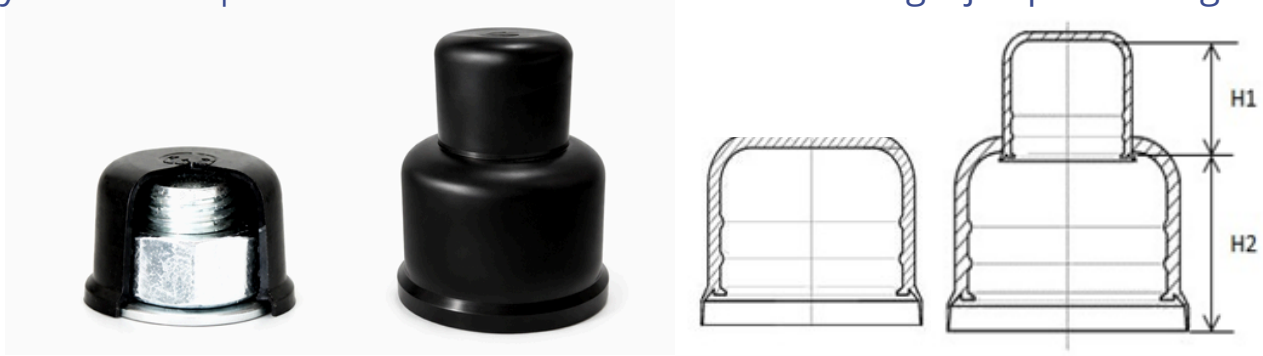

Artikelnummer	Tot. hoogte inw. (mm)	M	UNC	H1 (mm)	H2 (mm)	Ring-dikte (mm)	Ø Ring (mm)
SW7R-5	5	M4			5	0.8	9.0
SW8R-6	6	M5			6	1.0	10.0
SW10R-7	7	M6			7	1.6	12.0
SW10R-13	13	M6			13	1.6	12.0
SW10R-18	18	M6			18	1.6	12.0
SW11R-13	13				13	1.4	14.7
SW13R-10	10	M8	1/4"		10	1.6	16.0
SW13R-14	14	M8	1/4"		14	1.6	16.0
SW13R-19	19	M8	1/4"		19	1.6	16.0
SW13R-29	29	M8	1/4"		29	1.6	16.0
SW17R-12	12	M10	3/8"		12	2.0	20.0
SW17R-17	17	M10	3/8"		17	2.0	20.0
SW17R-47	47	M10	3/8"		47	2.0	20.0
SW19R-15	15	M12	7/16"		15	2.5	40.0
SW19R-20	20	M12	7/16"		20	2.5	40.0
SW19R-25	25	M12	7/16"		25	2.5	40.0

## Moerkappen + onderlegging bescherming - anti corrosie

Polyethyleen LD-PE | zwart standaard - alle RAL-kleuren mogelijk op aanvraag

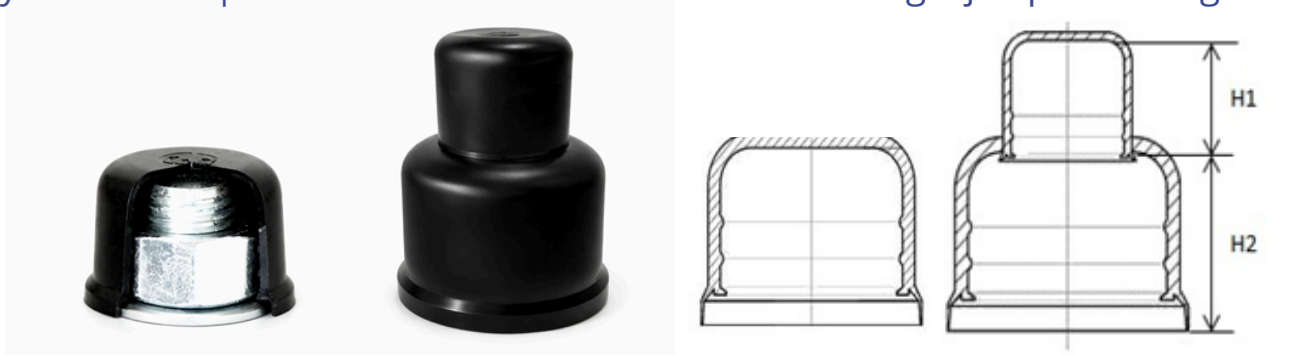

Artikelnummer	Tot. hoogte inw. (mm)	M	UNC	H1 (mm)	H2 (mm)	Ring-dikte (mm)	Ø Ring (mm)
SW19R-40	40	M12	7/16"		40	2.5	40.0
SW22R-22	22	M14	1/2"		22	2.5	28.0
SW22R-37	37	M14	1/2"		37	2.5	28.0
SW22R-48T	48 telescopic	M14	1/2"	15	37	2.5	28.0
SW22R-53T	53 telescopic	M14	1/2"	20	37	2.5	28.0
SW22R-57T	57 telescopic	M14	1/2"	24	37	2.5	28.0
SW24R-19	19	M16	9/16"		19	3.0	30.0
SW24R-24	24	M16	9/16"		24	3.0	30.0
SW24R-29	29	M16	9/16"		29	3.0	30.0
SW24R-34	34	M16	9/16"		34	3.0	30.0
SW24R-54	54	M16	9/16"		54	3.0	30.0
SW24R-69	69	M16	9/16"		69	3.0	30.0
SW24R-73T	73 telescopic	M16	9/16"	24	54	3.0	30.0
SW24R-85T	85 telescopic	M16	9/16"	20	69	3.0	30.0
SW24R-89T	89 telescopic	M16	9/16"	24	69	3.0	30.0
SW27R-26	26	M18	5/8"		44	3.0	34.0

## Moerkappen + onderlegging bescherming - anti corrosie

Polyethyleen LD-PE | zwart standaard - alle RAL-kleuren mogelijk op aanvraag

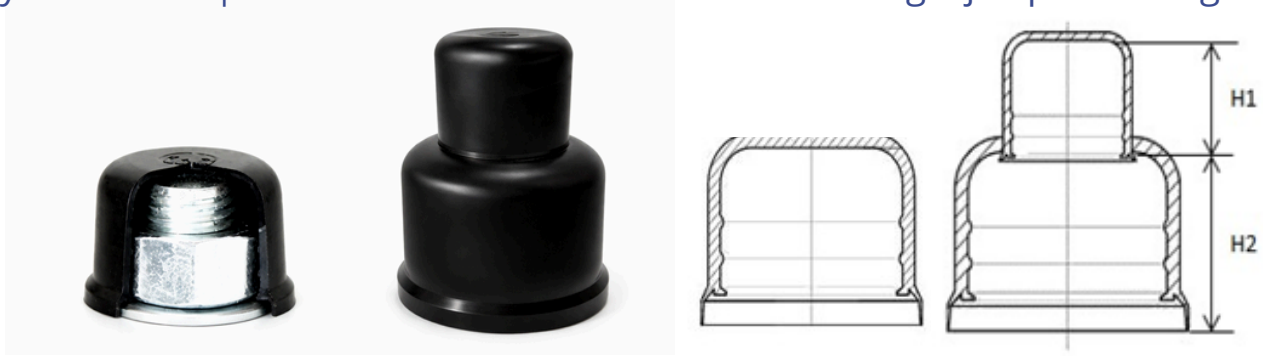

Artikelnummer	Tot. hoogte inw. (mm)	M	UNC	H1 (mm)	H2 (mm)	Ring-dikte (mm)	Ø Ring (mm)
SW27R-44T	44 telescopic	M18	5/8"	22	26	3.0	34.0
SW27R-49T	49 telescopic	M18	5/8"	27	26	3.0	34.0
SW27R-72T	72 telescopic	M18	5/8"	50	26	3.0	34.0
SW30R-25	25	M20			25	3.0	37.0
SW30R-30	30	M20			30	3.0	37.0
SW30R-37	37	M20			37	3.0	37.0
SW30R-40	40	M20			40	3.0	37.0
SW30R-52	52	M20			52	3.0	37.0
SW30R-70T	70 telescopic	M20		35	37	3.0	37.0
SW30R-82	82	M20			82	3.0	37.0
SW30R-95T	95 telescopic	M20		64	37	3.0	37.0
SW30R-102T	102 telescopic	M20		24	82	3.0	37.0
SW30R-112T	112 telescopic	M20		35	82	3.0	37.0
SW30R-115T	115 telescopic	M20		64	52	3.0	37.0
SW32R-40	40	M22	3/4"		40	3.0	39.0
SW32R-73T	73 telescopic	M22	3/4"	35	40	3.0	39.0

## Moerkappen + onderlegging bescherming - anti corrosie

Polyethyleen LD-PE | zwart standaard - alle RAL-kleuren mogelijk op aanvraag

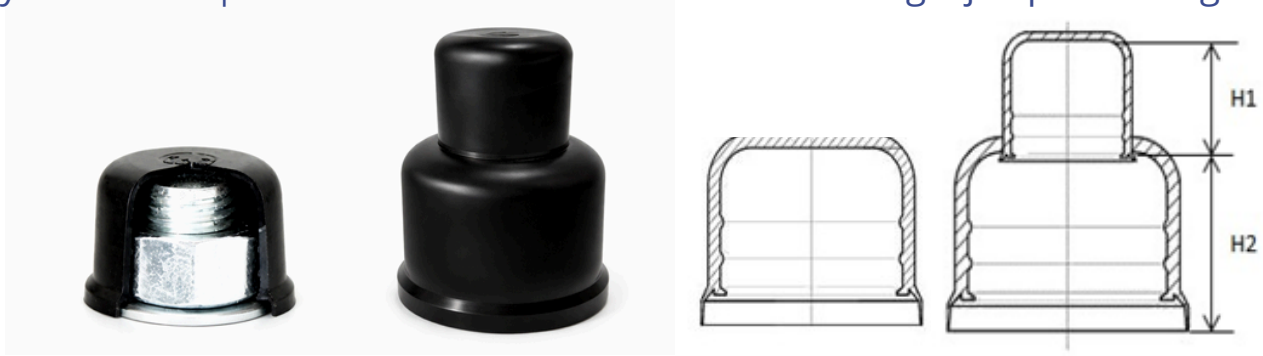

Artikelnummer	Tot. hoogte inw. (mm)	M	UNC	H1 (mm)	H2 (mm)	Ring-dikte (mm)	Ø Ring (mm)
SW32R-98T	98 telescopic	M22	3/4"	64	40	3.0	39.0
SW36R-32	32	M24	7/8"		32	4.0	44.0
SW36R-42	42	M24	7/8"		42	4.0	44.0
SW36R-56	56	M24	7/8"		56	4.0	44.0
SW36R-77	77	M24	7/8"		77	4.0	44.0
SW36R-83T	83 telescopic	M24	7/8"	31	56	4.0	44.0
SW36R-102T	102 telescopic	M24	7/8"	31	77	4.0	44.0
SW36R-103T	103 telescopic	M24	7/8"	51	56	4.0	44.0
SW36R-120	120	M24	7/8"		120	4.0	44.0
SW36R-121T	121 telescopic	M24	7/8"	51	77	4.0	44.0
SW36R-138T	138 telescopic	M24	7/8"	69	77	4.0	44.0
SW41R-35	35	M27	1"		35	4.0	50.0
SW41R-45	45	M27	1"		45	4.0	50.0
SW41R-70T	70 telescopic	M27	1"	30	45	4.0	50.0
SW41R-80	80	M27	1"		80	4.0	50.0
SW41R-105T	105 telescopic	M27	1"	30	80	4.0	50.0

## Moerkappen + onderlegging bescherming - anti corrosie

Polyethyleen LD-PE | zwart standaard - alle RAL-kleuren mogelijk op aanvraag

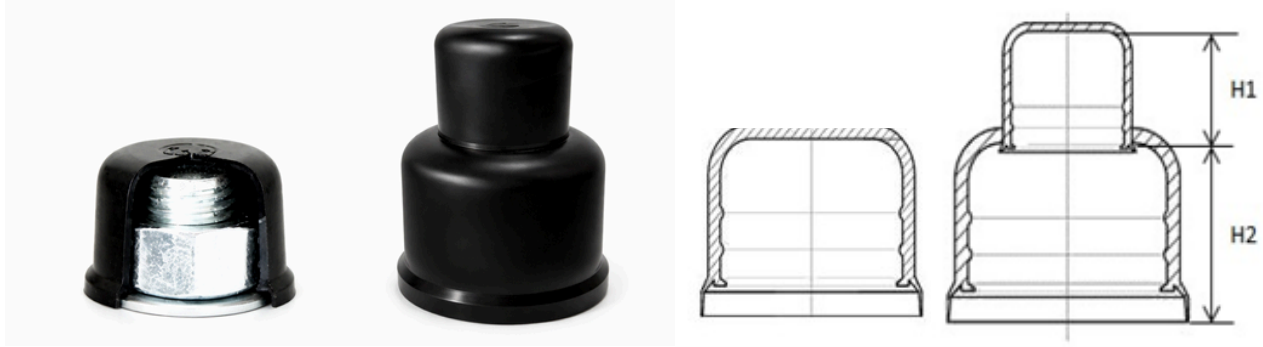

Artikelnummer	Tot. hoogte inw. (mm)	M	UNC	H1 (mm)	H2 (mm)	Ring-dikte (mm)	Ø Ring (mm)
SW46R-38	38	M30	1.1/8"		38	4.0	56.0
SW46R-53	53	M30	1.1/8"		53	4.0	56.0
SW46R-83	83	M30	1.1/8"		83	4.0	56.0
SW46R-87T	87 telescopic	M30	1.1/8"	39	53	4.0	56.0
SW46R-96T	96 telescopic	M30	1.1/8"	47	53	4.0	56.0
SW46R-115T	115 telescopic	M30	1.1/8"	39	83	4.0	56.0
SW46R-124T	124 telescopic	M30	1.1/8"	47	83	4.0	56.0
SW46R-155T	155 telescopic	M30	1.1/8"	79	83	4.0	56.0
SW50R-41	41	M33	1.1/4"		41	5.0	60.0
SW50R-56	56	M33	1.1/4"		56	5.0	60.0
SW50R-86	86	M33	1.1/4"		86	5.0	60.0
SW50R-88T	88 telescopic	M33	1.1/4"	37	56	5.0	60.0
SW50R-116T	116 telescopic	M33	1.1/4"	37	86	5.0	60.0
SW50R-195T	195 telescopic	M33	1.1/4"	120	86	5.0	60.0
SW55R-60	60	M36	1.3/8"		60	5.0	66.0
SW55R-90	90	M36	1.3/8"		90	5.0	66.0

## Moerkappen + onderlegging bescherming - anti corrosie

Polyethyleen LD-PE | zwart standaard - alle RAL-kleuren mogelijk op aanvraag

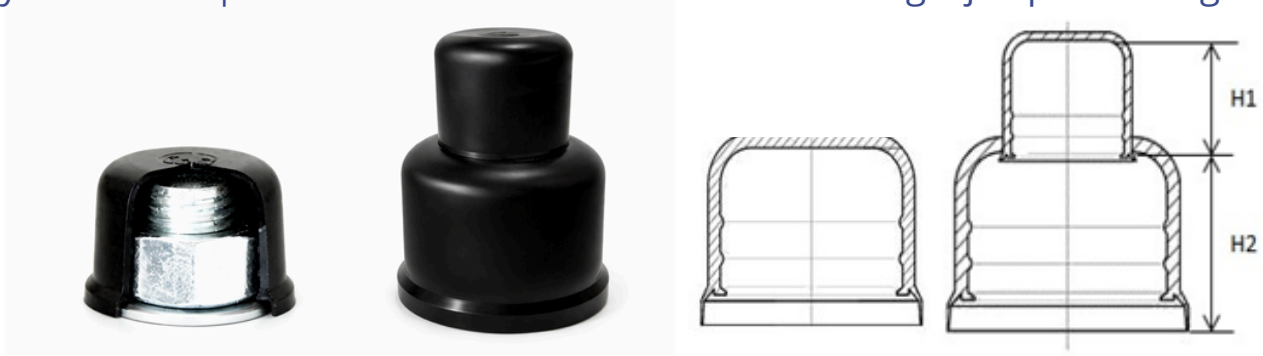

Artikelnummer	Tot. hoogte inw. (mm)	M	UNC	H1 (mm)	H2 (mm)	Ring-dikte (mm)	Ø Ring (mm)
SW55R-97T	97 telescopic	M36	1.3/8"	43	60	5.0	66.0
SW55R-125T	125 telescopic	M36	1.3/8"	43	90	5.0	66.0
SW55R-126T	126 telescopic	M36	1.3/8"	73	60	5.0	66.0
SW55R-154T	154 telescopic	M36	1.3/8"	73	90	5.0	66.0
SW55R-160	160	M36	1.3/8"		160	5.0	66.0
SW55R-200T	200 telescopic	M36	1.3/8"	52	160	5.0	66.0
SW55R-221T	221 telescopic	M36	1.3/8"	73	160	5.0	66.0
SW60R-63	63	M39	1.1/2"		63	6.0	72.0
SW60R-93	93	M39	1.1/2"		93	6.0	72.0
SW60R-130T	130 telescopic	M39	1.1/2"	76	63	6.0	72.0
SW60R-160T	160 telescopic	M39	1.1/2"	76	93	6.0	72.0
SW70R-70	70	M45	1.3/4"		70	7.0	88.0
SW70R-100	100	M45	1.3/4"		100	7.0	88.0
SW70R-112T	112 telescopic	M45	1.3/4"	79	70	7.0	88.0
SW70R-140	140	M45	1.3/4"		140	7.0	88.0
SW70R-141T	141 telescopic	M45	1.3/4"	79	70	7.0	88.0

## Moerkappen + onderlegging bescherming - anti corrosie

Polyethyleen LD-PE | zwart standaard - alle RAL-kleuren mogelijk op aanvraag

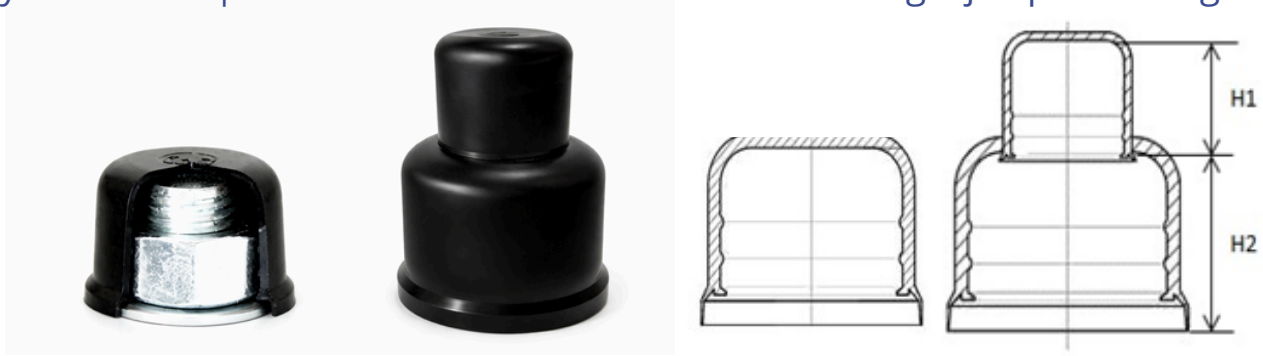

Artikelnummer	Tot. hoogte inw. (mm)	M	UNC	H1 (mm)	H2 (mm)	Ring-dikte (mm)	Ø Ring (mm)
SW70R-142T	142 telescopic	M45	1.3/4"	49	100	7.0	88.0
SW70R-171T	171 telescopic	M45	1.3/4"	79	100	7.0	88.0
SW70R-182T	182 telescopic	M45	1.3/4"	49	140	7.0	88.0
SW70R-211T	211 telescopic	M45	1.3/4"	79	140	7.0	88.0
SW75R-74	74	M48	1.7/8"		74	8.0	92.0
SW75R-103	103	M48	1.7/8"		103	8.0	92.0
SW75R-116	116	M48	1.7/8"		116	8.0	92.0
SW75R-116T	116 telescopic	M48	1.7/8"	49	74	8.0	92.0
SW75R-143T	143 telescopic	M48	1.7/8"	49	103	8.0	92.0
SW75R-145T	145 telescopic	M48	1.7/8"	79	74	8.0	92.0
SW75R-172T	172 telescopic	M48	1.7/8"	79	103	8.0	92.0
SW80R-139	139	M52	2"		139	8.0	98.0
SW80R-175T	175 telescopic	M52	2"	51	139	8.0	98.0
SW80R-205T	205 telescopic	M52	2"	81	39	8.0	98.0
SW85R-83	83	M56			83	9.0	105.0
SW85R-130T	130 telescopic	M56		55	83	9.0	105.0

## Moerkappen + onderlegging bescherming - anti corrosie

Polyethyleen LD-PE | zwart standaard - alle RAL-kleuren mogelijk op aanvraag

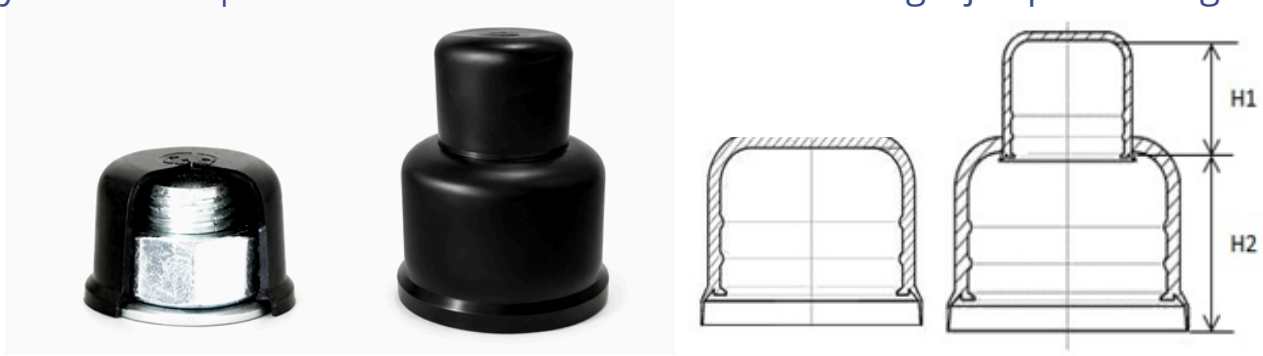

Artikelnummer	Tot. hoogte inw. (mm)	M	UNC	H1 (mm)	H2 (mm)	Ring-dikte (mm)	Ø Ring (mm)
SW85R-158T	158 telescopic	M56		85	83	9.0	105.0
SW90R-83	83	M60	2.1/4"		83	9.0	110.0
SW90R-125T	125 telescopic	M60	2.1/4"	57	83	9.0	110.0
SW90R-155T	155 telescopic	M60	2.1/4"	87	83	9.0	110.0
SW95R-140	140	M64			140	9.0	115.0
SW95R-181T	181 telescopic	M64		61	140	9.0	115.0
SW95R-211T	211 telescopic	M64		91	140	9.0	115.0
SW100R-150	150	M68	2.1/2"		150	10.0	120.0
SW100R-193T	193 telescopic	M68	2.1/2"	63	150	10.0	120.0
SW100R-223T	223 telescopic	M68	2.1/2"	93	150	10.0	120.0
SW105R-160	160	M72			160	10.0	125.0
SW105R-206T	206 telescopic	M72		66	160	10.0	125.0
SW105R-236T	236 telescopic	M72		96	160	10.0	125.0
SW107R-105	105	M76	2.3/4"		105	11.0	137.0
SW107R-156T	156 telescopic	M76	2.3/4"	70	105	11.0	137.0
SW107R-226T	226 telescopic	M76	2.3/4"	130	105	11.0	137.0

## Moerkappen + onderlegging bescherming - anti corrosie

Polyethyleen LD-PE | zwart standaard - alle RAL-kleuren mogelijk op aanvraag

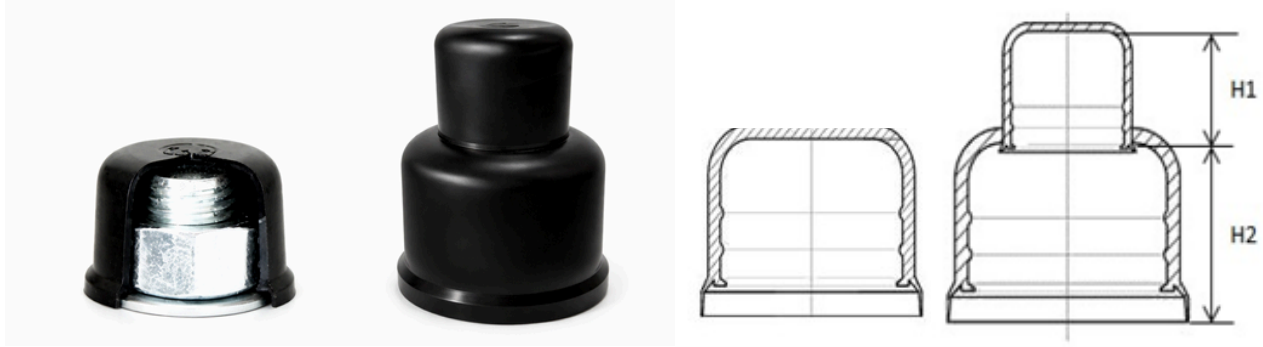

Artikelnummer	Tot. hoogte inw. (mm)	M	UNC	H1 (mm)	H2 (mm)	Ring-dikte (mm)	Ø Ring (mm)
SW117R-115	115	M85	3"		115	15.0	149.0
SW117R-173T	173 telescopic	M85	3"	78	115	15.0	149.0
SW117R-235T	235 telescopic	M85	3"	140	115	15.0	149.0
SW130R-125	125	M90	3.1/4"		125	15.0	159.0
SW130R-181T	181 telescopic	M90	3.1/4"	86	125	15.0	159.0
SW130R-238T	238 telescopic	M90	3.1/4"	143	125	15.0	159.0



## Toepassingen:

Afwerking bescherming en conservering moer/kop + onderlegging

## Moerkap inclusief bescherming special maat sluitring

Polyethyleen LD-PE | zwart standaard - alle RAL-kleuren mogelijk op aanvraag



Artikelnummer	Sleutelwijdte (mm)	M	UNC	Totale hoogte (mm)	Ø Ring (mm)	Hoogte ring (mm)
SWS8R-6	8	M 5		6	12	1
SWS8R-8	8	M 5		8	15	3
SWS13R-12	13	M 8		12	24,3	2,2
SWS13R-16	13	M 8	1/4	16	17,9	2,8
SWS13R-17	13	M 8	1/4	17	24	2
SWS17R-12	17	M 10	3/8	12	30,8	2,4
SWS17R-14	17	M 10	3/8	14	31	3,3
SWS17R-19	17	M 10	3/8	19	23,6	4
SWS19R-13	19	M 12	7/16	13	29,2	2,8
SWS19R-20	19	M 12	7/16	20	28,7	4,8
SWS19R-22	19	M 12	7/16	22	29	3,3
SWS19R-25	19	M 12	7/16	25	24,8	5,7
SWS19R-26	19	M 12	7/16	26	41	3
SWS24R-25	24	M 16	9/16	25	55	4,5
SWS24R-30	24	M 16	9/16	30	50,5	3,3
SWS24R-40T*	24	M 16	9/16	40 telescopisch	32	6

## Moerkap inclusief bescherming special maat sluitring

Polyethyleen LD-PE | zwart standaard - alle RAL-kleuren mogelijk op aanvraag



Artikelnummer	Sleutelwijdte (mm)	M	UNC	Totale hoogte (mm)	Ø Ring (mm)	Hoogte ring (mm)
SWS24R-65T*	24	M 16	9/16	65 telescopisch	32	6
SWS30R-36	30	M 20		36	61	4,6
SWS32R-54	32	M 22	3/4	54	41,5	7,5
SWS32R-85T	32	M 22	3/4	85 telescopisch	41,5	7,5
SWS32R-112T	32	M 22	3/4	112 telescopisch	41,5	7,5
SWS36R-44	36	M 24	7/8	44	72,7	5,4
SWS55R-174	55	M 36	1 3/8	174	70	25
SWS65R-174	65	M 42	1 5/8	174	81	33
SWS75R-119	75	M 48	1 7/8	119	93	23
SWS100R-100	100	M 68	2 1/2	100	124	21



## Toepassingen:

Afwerking bescherming en conservering van boutkop moer sluitring

[shop.juisma.nl](http://shop.juisma.nl) | [www.juisma.nl](http://www.juisma.nl) | [sales@juisma.nl](mailto:sales@juisma.nl)

# BoltRex HD | Speciale moerkap JUISMA®

Plastics & Rubber

## Moerkap voor speciale moer en/of sluitring - fixatie draadeind

Polyethyleen LD-PE | zwart standaard - alle RAL-kleuren mogelijk op aanvraag

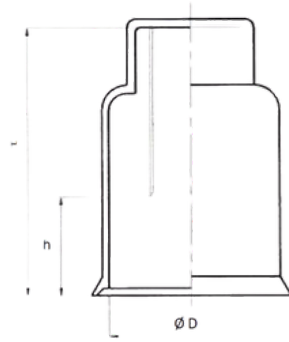
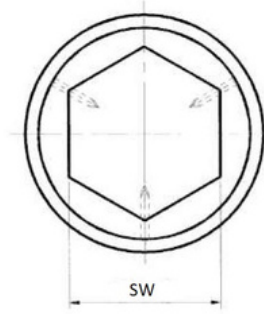

Artikelnummer	Totale inw. hoogte (mm)	M	UNC	SW (kop)	Ø D max (mm)	h max moer (mm)
BM36-115/65	115	M 16	1 3/8	36	67,8	65
BM36-115/43*	115	M 20	1 3/8	36	67,8	43
BM39-125/68	125	M 22	1 1/2	39	73,6	68
BM42-137/76	137	M 22	1 5/8	42	81,9	76
BM42-137/51*	137	M 22	1 5/8	42	81,9	81
BM45-145/81	145	M 24	1 3/4	45	88,2	81
BM45-145/54*	145	M 36	1 3/4	45	88,2	54
BM48-155/86	155	M 42	1 7/8	48	96	86
BM48-155/58*	155	M 48	1 7/8	48	96	58
BM48-205C	205	M 68	1 7/8	geen SW	93	119

\*) niet te gebruiken met (dubbele)contramoeren



## Toepassingen:

Bescherming en conservering van speciale moer-sluitring-draadeind

[shop.juisma.nl](http://shop.juisma.nl) | [www.juisma.nl](http://www.juisma.nl) | [sales@juisma.nl](mailto:sales@juisma.nl)

## Universele draadeindkap voor veilige en esthetische afwerking

Polyethyleen LD-PE | zwart R9005 (andere RAL-kleuren op aanvraag mogelijk)

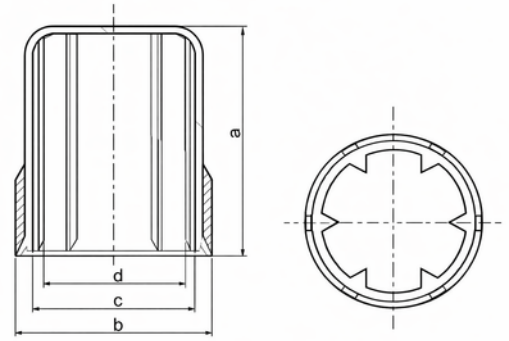

Artikelnummer	Metrisch	hoogte max. (mm)	Monteren met ringsleutel (mm)
SCM16-36	M16	36	24
SCM30-60	M30	60	46
SCM36-70	M36	70	55
SCM42-79	M42	79	65
SCM45-81	M45	81	70
SCM48-84	M48	84	75
SCM52-87	M52	87	80
SCM56-90	M56	90	85
SCM60-90	M60	90	90
SCM64-91	M64	91	95
SCM72-56	M72	56	105
SCM72-96	M72	96	105
SCM80-60	M80	60	115
SCM80-120	M80	120	115
SCM90-100	M90	100	130